

REV.	DATE	DESCRIPTION	DRAWN BY
V2.0	15.09.01		WELLING

1	NC
2	LED+
3	LED-
4	NC
5	NC
6	NC
7	NC
8	VDD
9	GND
10	VDDI
11	NC
12	/CS
13	IM2
14	SPI4W
15	/RST
16	RD
17	VDDI
18	D7
19	D6
20	D5
21	D4
22	D3
23	D2
24	D1
25	D0
26	WR
27	RS
28	ID
29	NC

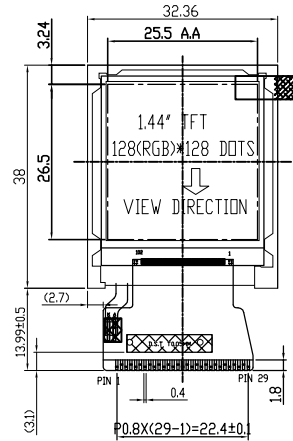

VIEWING DIRECTION

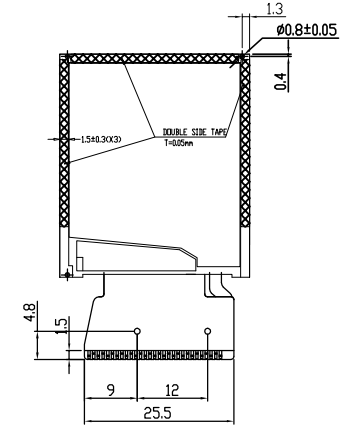
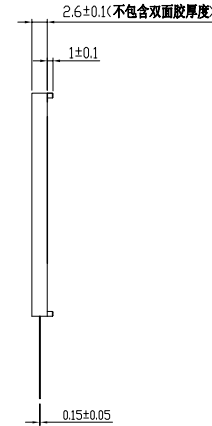

展开出货

NOTES:

- 1.DISPLAY TYPE: TFT-LCD, TRANSMISSIVE,
- 2.OPERATING TEMP: -20°C~70°C
- 3.STORAGE TEMP: -30°C~80°C
- 4.LCD DRIVER: ST7735S
- 5.VIEWING DIRECTION: 12 O'CLOCK
- 6.Backlight: 1 Chip-White LED (每灯20mA)
- 7.GENERAL TOLERANCE: ±0.2

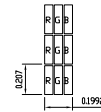

DETAIL A (FOR REFERENCE ONLY)

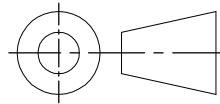
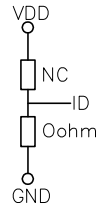
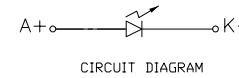

THIRD ANGLE PROJECT

DRG DATE	15.09.01	ROCKTECH DISPLAYS LIMITED			
DSN BY	WELLING				
CHK BY		TITLE	128(RGB) X 128 DOTS	SCALE	N.T.S
APPROVED		MODEL	RK014CE06A	UNITS	MM
		P/N		ISSUE	v2.0
		SHEET	OF	GENERAL TOLERANCE	±0.2